

REV	LOCATIONS	DESCRIPTION	DATE	REVISER	APPD
1	△	Dimensions change	19/DEC/19	KATE	CHERRY
2	△	Structural changes	19/MAR/21	KATE	CHERRY

SPECIFICATIONS

Electrical
 Current Rating: 0.5A AC(rms)/DC
 Voltage Rating: 50V AC(rms)/DC
 Contact Resistance: 30 m Ω Max
 Insulation Resistance: 500 M Ω MIN
 Withstanding Voltage: 200V AC r.m.s
 Temperature Range—Operating: -40°C~+85°C

Material and Plating
 Housing: PA6T UL 94V-0
 Actuator: PPS UL 94V-0
 Contact: Phosphor Bronze/ Tin or Gold Plated
 Stopper: Phosphor Bronze/ Tin Plated

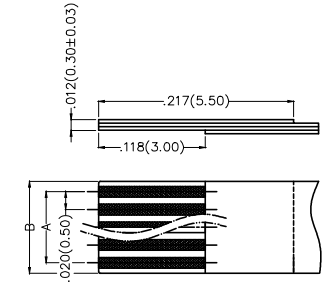
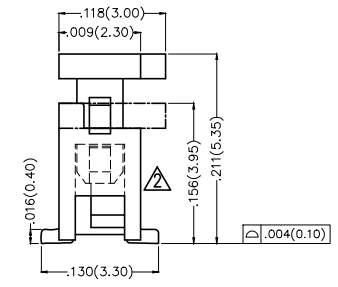
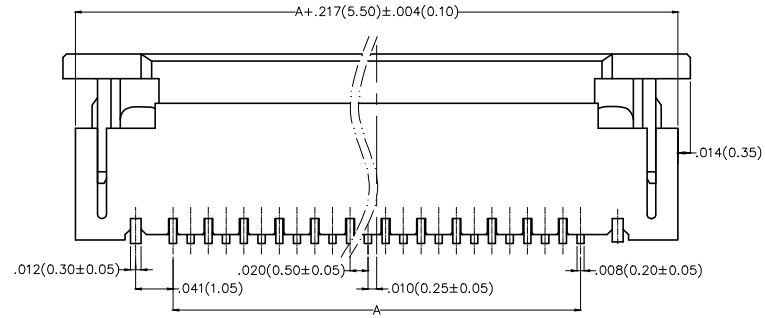
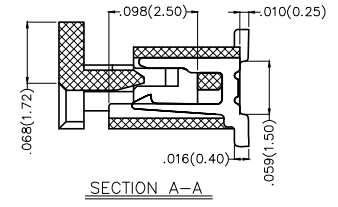
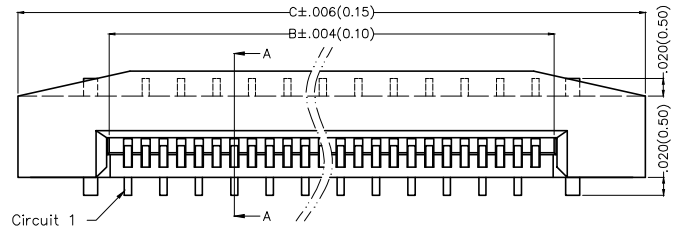

Applicable FFC
Recommended Dimension

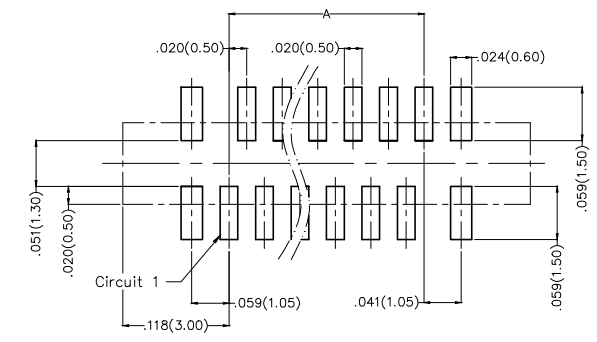

Recommended P.C.Board Layout
 General tolerances: ±.002(0.05)

Ordering Information

FFC 050 09 — XX S S A 1 X 4 W5 M
 1 2 3 4 5 6 7 8 9 10 11 12



1 Category FFC-FPC	2 Series Number 050-Pitch 0.50mm	3 Distinction No. 09	4 Circuits XX	5 Assemble Layout S-SMT	6 Entry Angle S-180° Vertical
7 Contact Position A-Positive Needle	8 ZIF 1-ZIF	9 Plating 2-Tin plated 1-Gold plated	10 Material-Resin 4-PA6T	11 Color-Resin W5-Housing: Natural, Actuator: Brown	12 Packaging M-Reel

 THIRD ANGLE PROJECTION	GENERAL TOLERANCES (UNLESS SPECIFIED)		APPROVE BY FRANK	DATE 18/JUN/13	PART NO. FFC05009-XXSSA1X4W5M	ITEM NO. FFC05009	 Leader Of Industry
	DESIGN UNITS Inch (metric)	X.±.012(0.30)	X.±5'	CHECKED BY JACOB	DATE 18/JUN/13	TITLE FPC/FFC connector 0.5mm Positive needle SMT	
SCALE 5:1	SIZE A4	X.XX±.006(0.15)	.XX±1'	DRAWN BY CHERRY	DATE 18/JUN/13	THIS DRAWING CONTAINS INFORMATION THAT IS PROPRIETARY TO TXGA INDUSTRIAL ELECTRONICS(S.Z)CO.,LTD AND SHOULD NOT BE USED WITHOUT WRITTEN PERMISSION	
						REV 2	SHEET NO.1/3

1 2 3 4 5 6 7 8

REV	LOCATIONS	DESCRIPTION	DATE	REVISER	APPD

Circuits (n)	Part No.	Dimensions(in/mm)			Circuits (n)	Part No.	Dimensions(in/mm)		
		A	B	C			A	B	C
4	FFC05009-04SSA1X4W5M	.059(1.50)	.098(2.50)	.303(7.70)	33	FFC05009-33SSA1X4W5M	.630(16.00)	.669(17.00)	.874(22.20)
5	FFC05009-05SSA1X4W5M	.079(2.00)	.118(3.00)	.323(8.20)	34	FFC05009-34SSA1X4W5M	.650(16.50)	.689(17.50)	.894(22.70)
6	FFC05009-06SSA1X4W5M	.098(2.50)	.138(3.50)	.343(8.70)	35	FFC05009-35SSA1X4W5M	.669(17.00)	.709(18.00)	.913(23.20)
7	FFC05009-07SSA1X4W5M	.118(3.00)	.157(4.00)	.362(9.20)	36	FFC05009-36SSA1X4W5M	.689(17.50)	.728(18.50)	.933(23.70)
8	FFC05009-08SSA1X4W5M	.138(3.50)	.177(4.50)	.382(9.70)	37	FFC05009-37SSA1X4W5M	.709(18.00)	.748(19.00)	.953(24.20)
9	FFC05009-09SSA1X4W5M	.157(4.00)	.197(5.00)	.402(10.20)	38	FFC05009-38SSA1X4W5M	.728(18.50)	.768(19.50)	.972(24.70)
10	FFC05009-10SSA1X4W5M	.177(4.50)	.217(5.50)	.421(10.70)	39	FFC05009-39SSA1X4W5M	.748(19.00)	.787(20.00)	.992(25.20)
11	FFC05009-11SSA1X4W5M	.197(5.00)	.236(6.00)	.441(11.20)	40	FFC05009-40SSA1X4W5M	.768(19.50)	.807(20.50)	1.012(25.70)
12	FFC05009-12SSA1X4W5M	.217(5.50)	.256(6.50)	.461(11.70)	41	FFC05009-41SSA1X4W5M	.787(20.00)	.827(21.00)	1.031(26.20)
13	FFC05009-13SSA1X4W5M	.236(6.00)	.276(7.00)	.480(12.20)	42	FFC05009-42SSA1X4W5M	.807(20.50)	.846(21.50)	1.051(26.70)
14	FFC05009-14SSA1X4W5M	.256(6.50)	.295(7.50)	.500(12.70)	43	FFC05009-43SSA1X4W5M	.827(21.00)	.866(22.00)	1.071(27.20)
15	FFC05009-15SSA1X4W5M	.276(7.00)	.315(8.00)	.520(13.20)	44	FFC05009-44SSA1X4W5M	.846(21.50)	.886(22.50)	1.091(27.70)
16	FFC05009-16SSA1X4W5M	.295(7.50)	.335(8.50)	.539(13.70)	45	FFC05009-45SSA1X4W5M	.866(22.00)	.906(23.00)	1.110(28.20)
17	FFC05009-17SSA1X4W5M	.315(8.00)	.354(9.00)	.559(14.20)	46	FFC05009-46SSA1X4W5M	.886(22.50)	.925(23.50)	1.130(28.70)
18	FFC05009-18SSA1X4W5M	.335(8.50)	.374(9.50)	.579(14.70)	47	FFC05009-47SSA1X4W5M	.906(23.00)	.945(24.00)	1.150(29.20)
19	FFC05009-19SSA1X4W5M	.354(9.00)	.394(10.00)	.598(15.20)	48	FFC05009-48SSA1X4W5M	.925(23.50)	.965(24.50)	1.169(29.70)
20	FFC05009-20SSA1X4W5M	.374(9.50)	.413(10.50)	.618(15.70)	49	FFC05009-49SSA1X4W5M	.945(24.00)	.984(25.00)	1.189(30.20)
21	FFC05009-21SSA1X4W5M	.394(10.00)	.433(11.00)	.638(16.20)	50	FFC05009-50SSA1X4W5M	.965(24.50)	1.004(25.50)	1.209(30.70)
22	FFC05009-22SSA1X4W5M	.413(10.50)	.453(11.50)	.657(16.70)	51	FFC05009-51SSA1X4W5M	.984(25.00)	1.024(26.00)	1.228(31.20)
23	FFC05009-23SSA1X4W5M	.433(11.00)	.472(12.00)	.677(17.20)	52	FFC05009-52SSA1X4W5M	1.004(25.50)	1.043(26.50)	1.248(31.70)
24	FFC05009-24SSA1X4W5M	.453(11.50)	.492(12.50)	.697(17.70)	53	FFC05009-53SSA1X4W5M	1.024(26.00)	1.063(27.00)	1.268(32.20)
25	FFC05009-25SSA1X4W5M	.472(12.00)	.512(13.00)	.716(18.20)	54	FFC05009-54SSA1X4W5M	1.043(26.50)	1.083(27.50)	1.287(32.70)
26	FFC05009-26SSA1X4W5M	.492(12.50)	.531(13.50)	.736(18.70)	55	FFC05009-55SSA1X4W5M	1.063(27.00)	1.102(28.00)	1.307(33.20)
27	FFC05009-27SSA1X4W5M	.512(13.00)	.551(14.00)	.756(19.20)	56	FFC05009-56SSA1X4W5M	1.083(27.50)	1.122(28.50)	1.327(33.70)
28	FFC05009-28SSA1X4W5M	.531(13.50)	.571(14.50)	.776(19.70)	57	FFC05009-57SSA1X4W5M	1.102(28.00)	1.142(29.00)	1.346(34.20)
29	FFC05009-29SSA1X4W5M	.551(14.00)	.591(15.00)	.795(20.20)	58	FFC05009-58SSA1X4W5M	1.122(28.50)	1.161(29.50)	1.366(34.70)
30	FFC05009-30SSA1X4W5M	.571(14.50)	.610(15.50)	.815(20.70)	59	FFC05009-59SSA1X4W5M	1.142(29.00)	1.181(30.00)	1.386(35.20)
31	FFC05009-31SSA1X4W5M	.591(15.00)	.630(16.00)	.835(21.20)	60	FFC05009-60SSA1X4W5M	1.161(29.50)	1.201(30.50)	1.406(35.70)
32	FFC05009-32SSA1X4W5M	.610(15.50)	.650(16.50)	.854(21.70)					

 THIRD ANGLE PROJECTION	GENERAL TOLERANCES (UNLESS SPECIFIED)		APPROVE BY FRANK	DATE 18/JUN/13	PART NO. FFC05009-XXSSA1X4W5M	ITEM NO. FFC05009	 Leader Of Industry	
	X.±.012(0.30)	X.±5'	CHECKED BY JACOB	DATE 18/JUN/13	TITLE FFC/FFC connector 0.5mm Positive needle SMT			REV 2
	DESIGN UNITS Inch (metric)	X.XX±.008(0.20)	.X'±2'	DRAWN BY CHERRY	DATE 18/JUN/13	THIS DRAWING CONTAINS INFORMATION THAT IS PROPRIETARY TO TXGA INDUSTRIAL ELECTRONICS(S.Z)CO.,LTD AND SHOULD NOT BE USED WITHOUT WRITTEN PERMISSION		
	SCALE 5:1	SIZE A4	X.XX±.006(0.15)	.XX'±1'				

1 2 3 4 5 6 7 8

REV	LOCATIONS	DESCRIPTION	DATE	REVISED	APPD

- Note:
- 10 sprocket hole cumulative tolerance $\pm 0.2\text{mm}$
 - Carrier camber is within 1.0mm in 250mm
 - Material: Black Conductive polystyrene Alloy 100% recyclable
 - All dimensions meet EIA-481-3 requirements
 - Peel off force of cover tape & carrier tape: 20g~130g(0.2N~1.3N)
 - Component load per 13" reel: 1,000 pcs

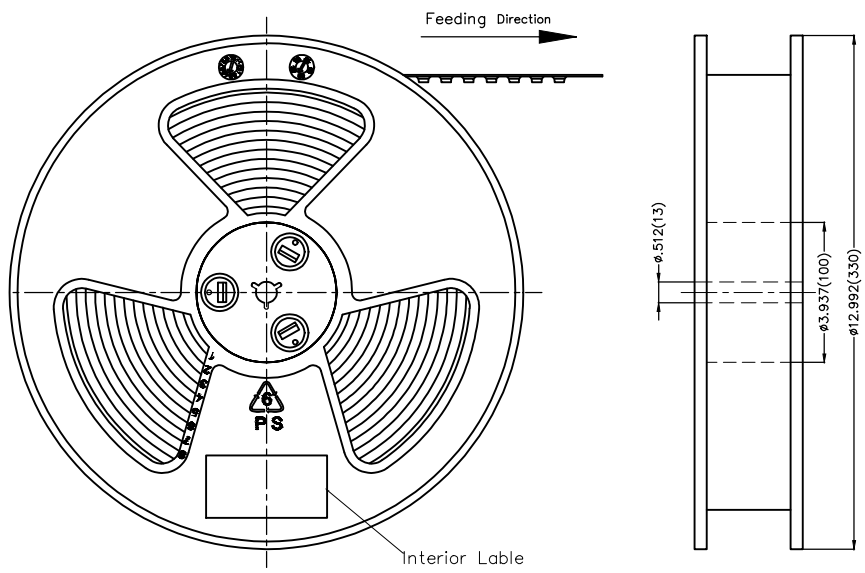

Circuits (n)	Dimensions(in/mm)		
	A	B	C
4~7	.630(16.0)	.295(7.5)	-
8~22	.945(24.0)	.453(11.5)	-
23~32	1.260(32.0)	.561(14.25)	1.122(28.50)
33~50	1.732(44.0)	.797(20.25)	1.594(40.50)
51~60	2.205(56.0)	1.033(26.25)	2.067(52.50)

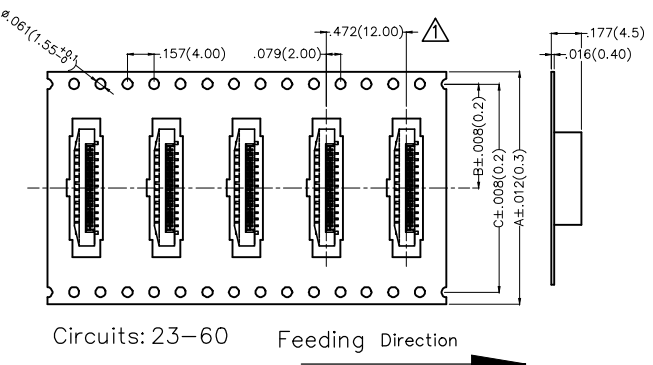
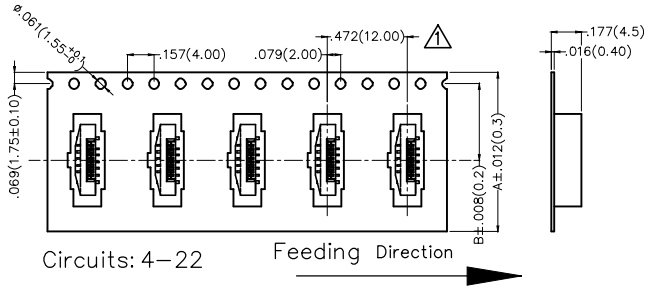
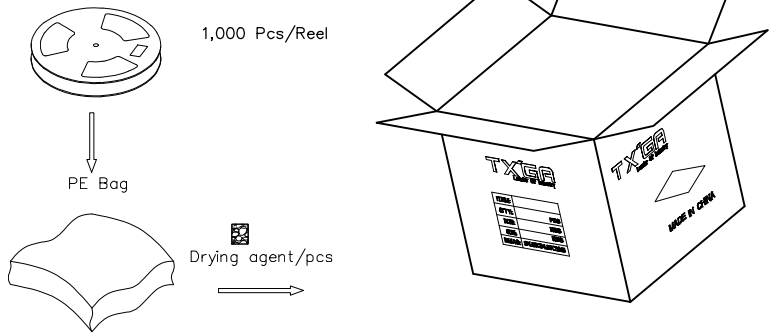
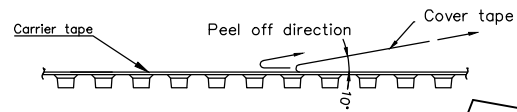
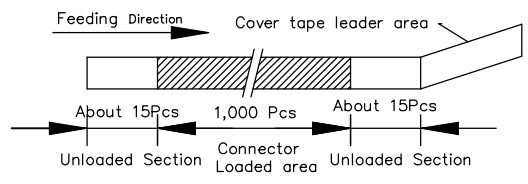

 THIRD ANGLE PROJECTION	GENERAL TOLERANCES (UNLESS SPECIFIED)		APPROVE BY	DATE	PART NO.	ITEM NO.	 Leader Of Industry
	X.±.012(0.30)	X'.±5'	FRANK	18/JUN/13	FFC05009-XXSSA1X4W5M	FFC05009	
DESIGN UNITS	X.X±.008(0.20)	.X'±2'	CHECKED BY	DATE	TITLE	REV 2 SHEET NO. 3/3	
Inch (metric)	X.XX±.006(0.15)	.XX'±1'	JACOB	18/JUN/13	FPC/FFC connector 0.5mm Positive needle SMT	THIS DRAWING CONTAINS INFORMATION THAT IS PROPRIETARY TO TXGA INDUSTRIAL ELECTRONICS(S.Z)CO.,LTD AND SHOULD NOT BE USED WITHOUT WRITTEN PERMISSION	
SCALE	X.XXX±.004(0.10)	.XXX'±0.5'	DRAWN BY	DATE			
5:1			CHERRY	18/JUN/13			